



mar345S Owner's Guide



mar345S

Image Plate Detector System

Owner's Guide

Version 1.0

October 2016

Written by Dr. Claudio Klein

Copyright 2016 marXperts GmbH

All rights reserved.

1. How to use this manual

Before you start to operate the **mar345S** Image Plate Detector System please read the Owner's Guide and the Technical Documentation included in the documentation package carefully.









1.1 Address and support

Should you have questions concerning the system or its use, please contact us via phone or email.

marXperts GmbH
Werkstr. 3
22844 Norderstedt / Germany
Tel.: +49 (40) 529 884 - 0
Fax: +49 (40) 529 884 - 20
info@marxperts.com
mar345.marxperts.com

1.2 Security and handling

When working with the **mar345S** detector system, observe the following security instructions in order to protect yourself and the instrument from harm.

Hazard	Description
	The mar345S detector system is intended for indoor use only.
	Do not install the instrument during an electrical storm.
	Never let liquids get inside the instrument. Otherwise, electric shocks or short circuits may result.
	Do not open the detector housing without instructions. The device contains hazardous components and should only be opened by authorized technicians.
	Place the instrument in a dry location that is free of dust and protected from moisture.
	Do not expose the detector to strong magnetic fields. They might corrupt the firmware. Strong magnetic fields may also have an impact on the analog reading circuits.
	Do not expose the detector to strong emitters of electromagnetic waves.
	Make sure that the ventilation slits in the detector are unobstructed. The ventilation slits provide for air cooling of the detector.

1.3 Disclaimer

This document is provided to customers as a courtesy of marXperts GmbH. The described operations require knowledge about mechanical and electrical components and should only be carried out by properly trained persons. While every precaution has been taken in the preparation of this document, marXperts GmbH assumes no responsibility for errors or omissions. Accordingly, marXperts GmbH cannot assume responsibility for damage to electrical or mechanical components of the instrument that occurred while following this guide. The entire risk of the operation remains with the person or institution carrying out the operation.

2. Overview

2.1 Principle of operation

The **mar345S** Image Plate Detector is a high speed scanner for so-called image plates. Image plates feature a photo-stimulable phosphor, typically BaF(Br,I):Eu²⁺. This compound is capable of storing X-rays in a broad energy range (5 keV to 100 keV) by pumping electrons from the valence into the conduction band where they can stay over longer periods of time (hours to days). When stimulated by red laser light, typically around 630 nm wavelength, the trapped electrons return to the ground state while emitting a blue photon (390 nm). The blue photons are counted by a photomultiplier. Their quantity is proportional to the amount of absorbed X-ray photons.

Image plate scanners are extremely sensitive integrating X-ray detectors. In contrast to electronic detectors like CCD's the read-out process is virtually noise-less. This is why even very low levels of X-rays can be recorded on image plates. Thus, image plate scanners are ideal detectors for all X-ray applications where noise becomes a crucial factor and where the detector read-out time is not the time-limiting step of the experiment.

Among all available image plate scanners, the **mar345S** Image Plate Detector outstands for its very short read-out time (down to 21 secs for a scan of 180 mm diameter) and its unsurpassed data quality. The key design feature is a single image plate of 345 mm diameter that is read out by driving a reading head over a spinning plate yielding spiral raw data. Since the plate itself is mounted in a fixed position the distance between the photon collector and the image plate surface is much smaller than in other image plate scanners making the **mar345S** the most sensitive and fastest detector of them all.

2.2 Hardware

2.2.1 Detector configurations

The **mar345S** Image Plate Detector comes in 3 possible configurations that differ in pixelsize and scantime. Hardware-wise they are identical except of the controller that is specific for a given configuration. In any case, each mar345 detector features 8 scan modes according to the following table that also gives the total scan and cycle times:

mar345S 150 μ m FINE/ 150 μ m FAST								
Scanned diameter	180 mm		240 mm		300 mm		345 mm	
Scan mode	150 μ	Fast	150 μ	Fast	150 μ	Fast	150 μ	Fast
Read-out time [sec]	26	9	39	15	56	23	68	30
Total cycle time [sec]	34	27	48	34	66	43	80	53

mar345S 100 μ m FINE/ 150 μ m FAST								
Scanned diameter	180 mm		240 mm		300 mm		345 mm	
Scan mode	100 μ	Fast	100 μ	Fast	100 μ	Fast	100 μ	Fast
Read-out time [sec]	34	9	53	15	77	23	96	30
Total cycle time [sec]	42	27	62	34	87	43	108	53

mar345 150 μM FINE/ 100 μM FINE

Scanned diameter	180 mm		240 mm		300 mm		345 mm	
Scan mode	150 μ	100 μ	150 μ	100 μ	150 μ	100 μ	150 μ	100 μ
Read-out time [sec]	26	34	39	53	56	77	68	96
Total cycle time [sec]	34	52	48	62	66	87	80	108

2.2.2 Data collection configurations

The **mar345s** Image Plate Detector usually is combined with some kind of goniostat system. The following hardware configurations are possible:

Description

Stand-alone



Due to its compact design, the scanner can easily be integrated into basically any X-ray data collection setup. The scanner electronics provides a TTL-signal for operating a shutter. It also provides a source of high voltage (for feeding ionization chambers) as well as steps for driving up to 3 stepper motors. Thus, by means of the provided software, the scanner may control an entire experiment.

mar345dtb

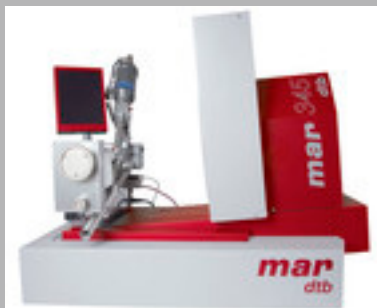

The mar345s detector is mounted on a mardtb goniostat. The mardtb “desktop beamline” features a fully automatic beam alignment system and more than 10 motors including an “inverted PHI” assembly and a 2-theta stage. The mar345dtb system is a complete data collection system that can be operated with any X-ray source (sealed tubes to synchrotrons), the most cost efficient combination being the marYX2G system.

mar μ X^{2G}



A mar345s detector with a mardtb goniostat in combination with a mar μ S microfocus generator. This system is the perfect choice, when cost-of-ownership and maintenance issues come into play. Despite of the low price, the system is highly suitable for screening samples, but also for complete data collections of small crystals.

3. Software

3.1 Software Distribution

The **mar345s** detector system comes with a software distribution. The contents and structure of this distribution is described in a separate document, the **mar345dtb** Software Distribution Guide. This guide applies to all forms of existence of the mar345s detector system, i.e. for stand-alone detectors or combinations of the detector with goniostats. The guide is available offline and online at:

<http://www.marxperts.com/pdf/mar345dtb-dist-guide.pdf>

3.2 Detector driving programs

For use as a stand-alone detector or together with the standard marresearch goniostat, we offer an X-window based GUI - program "mar345" - and a terminal driven program called "scan345". Both programs run on Linux, Mac OS X and Windows (GUI in cygwin environment). A manual for program "mar345" is available offline in directory man/mar345 of the marXperts software distribution and online at:

<http://www.marxperts.com/man/mar345>

For the plain server program "scan345", please refer to the Unix man style documentation, e.g. under

<http://www.marxperts.com/man/html/scan345.html>

For use with the **mar345dtb** "desktop beamline" please refer to the **mar345dtb** User's Guide. This manual is available offline in directory man/mar345dtb of the marXperts software distribution and online at:

<http://www.marxperts.com/man/mar345dtb>

4. First steps

4.1 Starting up

The **mar345S** detector system is shipped together with a computer and is ready to go within minutes after unpacking. To take it into operation, do the following:

1. Plug in a power cord at the back of the detector.
2. Plug in an Ethernet cable and connect it to the PC. On recent detectors with serial numbers > 400 a plain Ethernet cable can be used to directly connect to the PC. On older scanners a cross-over cable may be required. If a switch or hub is placed inbetween the detector and the PC, any cable can be used since those devices automatically detect the type of cable. The IP-address of the mar345 detector is set to 192.0.2.1 and cannot be changed. The PC connecting to the mar345 must have its IP-address set to 192.0.2.2. This is most easily achieved by using a dedicated Ethernet card.
3. Turn on the green power button of the detector. The detector boots up within approx. 70 seconds. At the end of the detector initialization process, the reading head of the detector is moved to its home position and a solenoid is activated to fix the image plate in its home position. The activation of the solenoid produces a characteristic sound and can be used to acoustically check when the initialization procedure is finished.
4. Turn on the computer, login as mar345 user and start program mar345, scan345, mar345dtb or any custom program capable of talking to the mar345 scanner. For this to work it is assumed that the mar345 programs have been installed properly with all the environment variables set correctly and with the scanner specific calibration and configuration files present in its expected place. Please note, that the mar345 cannot be used productively without its calibration and configuration files. It is also assumed, that IP-address 192.0.2.1 can be seen from the PC (to verify, try "ping 192.0.2.1"). The proper software setup is described elsewhere, e.g. the "**mar345dtb** Software Distribution Guide".

4.2 Scanning

The **mar345S** detector system offers 8 scan modes:

- 4 plate diameters: 345, 300, 240 or 180mm
- 2 pixel sizes for each diameter: 100 μm or 150 μm

As described in section 2.2.1, the mar345S detector comes with different types of controllers and the possibility to use a fast and fine 150 μm scan mode. The fast 150 μm mode is taking half the scan time of the fine 150 μm mode and gives slightly worse spatial resolution. The fast scan modes can be used, when beam properties don't allow for very high details, i.e. for most inhouse X-ray sources. The quality degradation of the data for fast scan modes compared to the fine scan modes is practically invisible for protein data and difficult to prove for other data. A high quality synchrotron beam may yield slightly better data from 100 μm scans. Keep in mind, that the fine 100 μm scans take considerable longer than the fine 150 μm scans and even more than the fast 150 μm scans, e.g. for the scan of the full 345 mm plate:

96 sec (100 μm) -> 68 sec (fine 150 μm) -> 34 sec (fast 150 μm)

The choice of the scan mode essentially is a scientific decision. The following rules of thumb apply:

- Choose the diameter according to the limits of diffraction. If the diffraction of the sample does not extend to the edge of the plate, you may as well use 300 mm scans or less. Using the full diameter does not really hurt, but the experiment is going to take more time than necessary. Also processing and backing up the data will consume more resources.
- If either the quality (large mosaicity) of the sample or the quality of the beam (high divergence) is responsible for a large spread of the signal, it does not really help to use the small pixel size modes: the optical resolution will never become better than the physical diffraction. Again, it does not really hurt to use 100 μm pixel size instead of 150 μm , but the experiment takes longer than necessary and the results won't become better just because of the smaller pixel size.

5. Maintenance

The **mar345S** detector system requires only few regular routine maintenance over its lifetime. There are only few consumable parts inside the detector, essentially the erase lamps and filter mats of the fans.

5.1 Erase lamps

Erase lamps have an expected lifetime of 2000 hours of operation. Since with every scan the erase lamps are turned on for approx. 15 minutes, this would produce an average failure of an erase lamp in 480.000 scans, which is more than even the most used detectors have seen in their lifetime. Due to a number of reasons the observed failure rates of the erase lamps are much shorter but still in the range of several ten thousands of scans, so it is possible that you may never have to change them. Still, if they are broken, they must be replaced because they are responsible for removing residual diffraction from the image plate after an exposure with X-ray. While 90% or more of the signal has already been wiped out by the read-out process itself, it is necessary to clean the remaining part by use of white light. This is particularly important for experiments with high energy X-rays beyond 8 keV as emitted by Cu targets.

The detector features 2 types of erase lamps, one 118 mm halogen lamp with 500 W sitting close to the reading head and 2 shorter 78 mm halogen lamps with 250 W sitting at the edge of the plate on the ground plate. All of them are plain halogen lamps with conventional RS7 sockets that can be purchased in local stores, although it may be somewhat difficult to find lamps with 500 W and 250 W in your local store next door. You can purchase replacement parts from marXperts but you can as well purchase your own stock. You should make sure that the long 118 mm lamp produces approx. 9000 lumen and the small ones approx. 4000 lumen. The 500 Watt lamp is more likely to break, because it produces a lot of heat. Also, it is turned on after every scan, while the small lamps are activated only for scans at 345 and 300 mm diameter. For scans at 240 and 180 mm the short 250 W lamps stay dark since they are without effect for the the inner circles of the plate.

Please see Appendix A.3 for details about how to replace the erase lamps

5.2 Filter mats

The cover of the detector comes with 6 ventilation areas that need to stay unobstructed in order for the air circulation to take place. The front cover has 1 inlet in the front for fresh air and 2 outlets for warm air at the top of the instrument. The back cover has 1 inlet at the back and 1 outlet at the top. The center cover has 1 inlet. Behind all inlets and outlets you will find a filter mat that protects the inside of the detector. With time the mats will become dirty, especially the ones sitting in front of a fan at the outlets. They need to be cleaned and/or replaced in regular intervals. It is suggested to do this every 6 to 12 months, depending on dust and other particles in the environment. If they become too dirty, it is possible that the detector suffers from overheating.

Please see Appendix A.4 for details about how to replace the filter mats.

5.3 Image plate

With time, the image plate itself may become dirty. A dust layer or other firm particles may pollute the otherwise white surface of the image plate. It is possible and suggested to clean the image from time to time, but you need to be careful not to damage the plate. For cleaning you can use a very soft lint-free tissue. You should use high grade ethanol or isopropanol as cleaning liquid and softly wipe over the surface of the plate. Do NOT use acetone or other chemicals.

You may also use soft tissues and ethanol/isopropanol to clean the black or silver mylar foil of the front window of the front cover. Please note, that this window is thin and when handling it improperly you can damage it. In particular you must make sure that you don't touch the window with sharp tools like pins, scissors, pliers and alike. A tear in the front window requires a replacement of the front window. The function of the mylar window is to leave X-rays through and to keep visible light out.

6. Troubleshooting

The **mar345S** detector system is extremely robust and may work over years without any kind of service. Still, like any other instrument it may produce hardware faults with time. Most of them are relatively straightforward to solve, since the detector is built in a modular way that allows for replacement of many parts without major hassle. This does not apply to the assembly of the image plate and the image plate motor as well as the laser in the read-out system. A failure of these components require a factory repair while all other components can be repaired on-site.

Crucial for any kind of service work is the proper diagnostics of the problem. In case of doubt, please collect as much information as possible about the observed problem before you contact marXperts. The detector controller produces a wealth of important information that is usually written into the log files of the used software. In most cases we will therefore ask you to send us the log file in order to understand the nature of the problem and if we are really looking at a detector fault or may be something else, e.g. a problem with the PC, the network connection or just a problem in the diffraction experiment.

Please see Appendix A for some typical problems and their solutions.

7. Specifications

Specifications	
Plate diameter	345 mm
Usable detector area	93.480 mm ²
Diameter of scanned area	180, 240, 300 or 345 mm
Pixel size (depending on controller)	150 µm fine & 150 µm fast 100 µm fine & 150 µm fast 150 µm fine & 100 µm fast
Sensitivity	1 X-ray photon per ADC-unit at 8 keV
Energy range	4keV to 100 keV X-ray photons
Intrinsic noise	2< 1 photon equivalent
Dynamic range	1:131.000 (17-bit)
Communication interface	Ethernet (RJ-45), 10 MBit/sec
Input power	240 V AC, 7.5 A peak current 115 V AC, 15 A peak current
Max. humidity	70%
Temperature range	4 - 24 C
Energy consumption	< 1500 W (peak)
Weight	53 kg
Dimensions W x L x H	515 x 350 x 398 mm
Erase lamps	1 halogen lamp R7S 11x118 mm, 500 W 2 halogen lamps R7S 11x78 mm, 250 W

Appendix

A. Service and maintenance

A.1 Remove front and rear cover

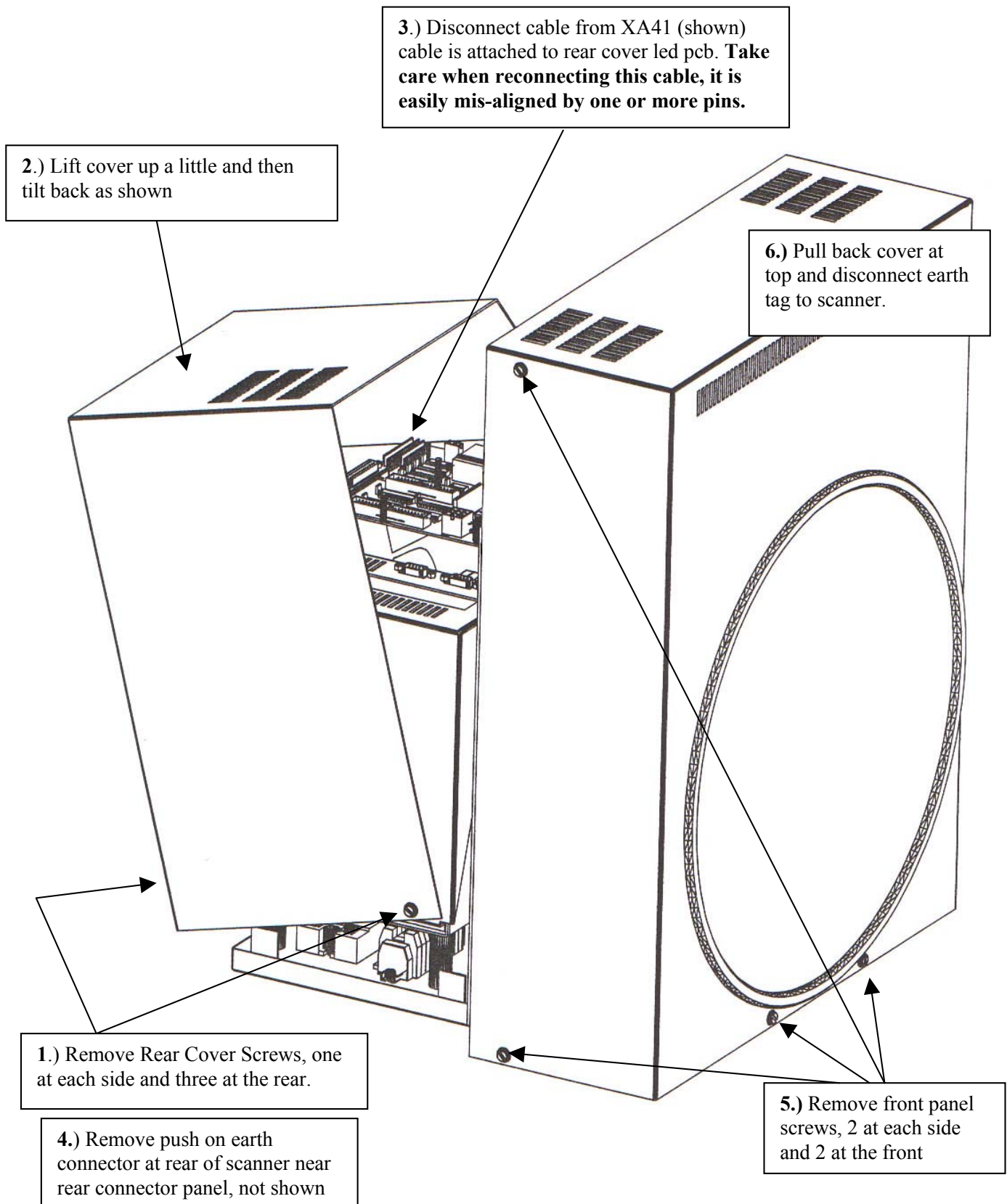

A.2 Remove center cover

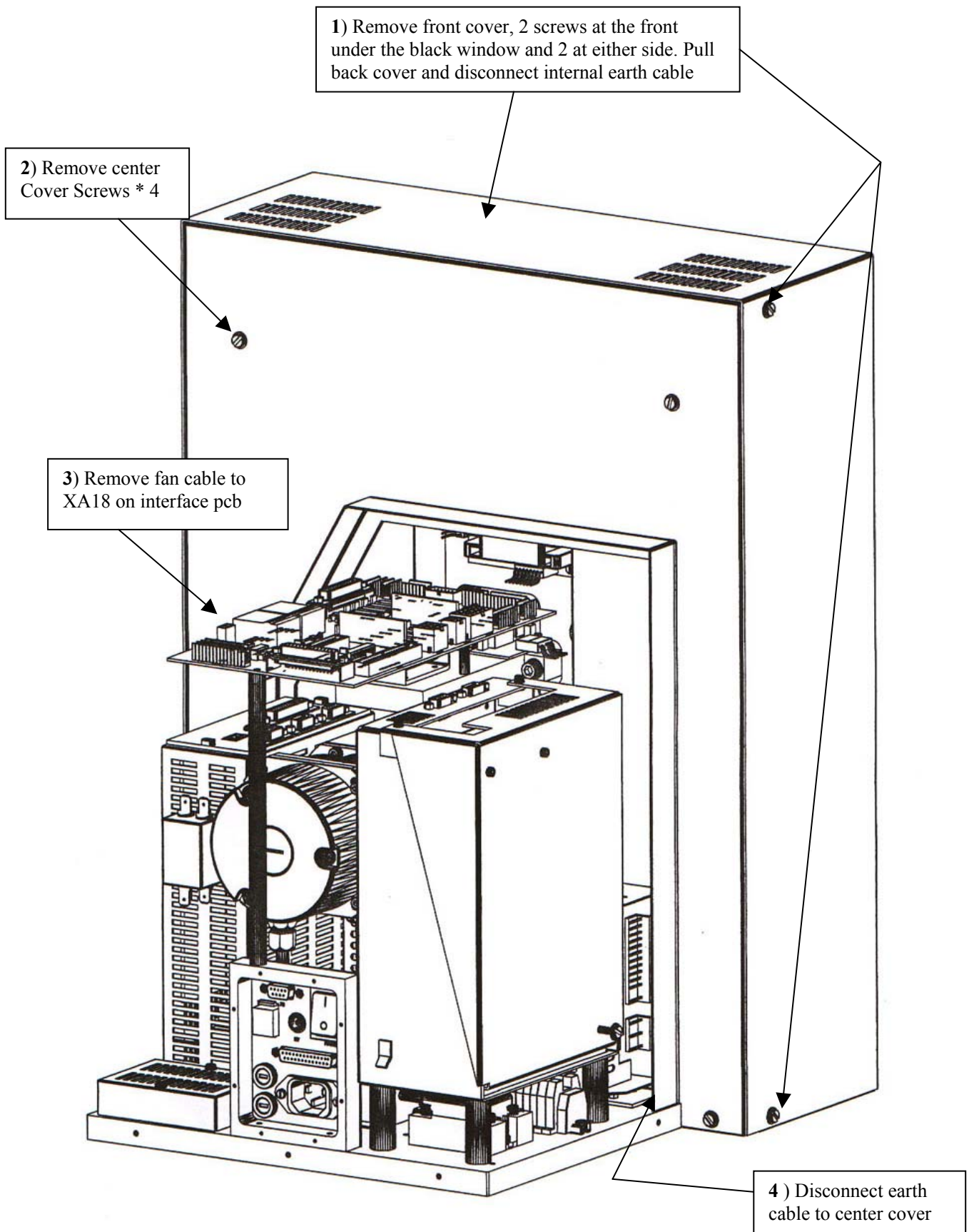

A.3 Scanner front

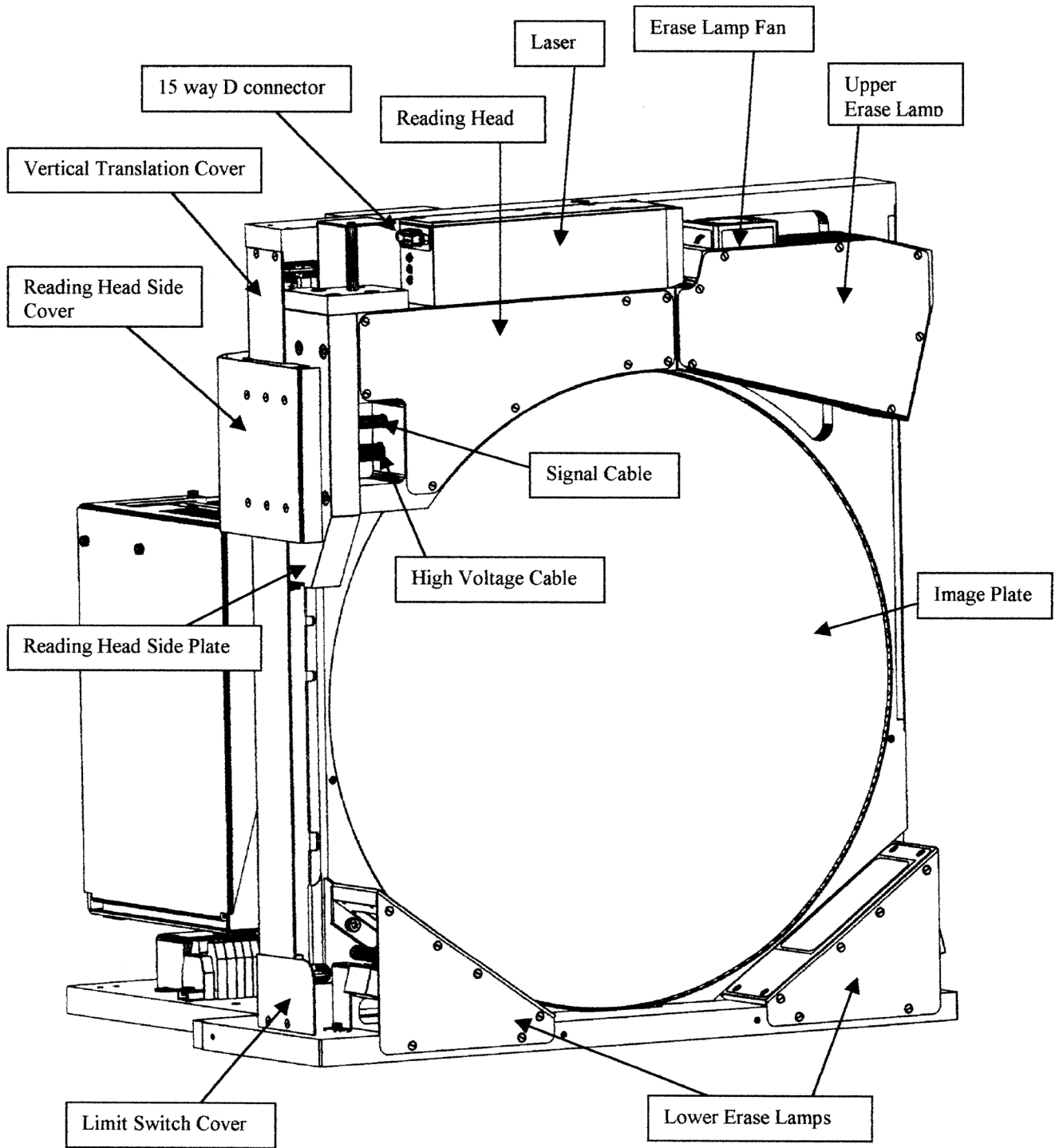

A.4 Scanner back

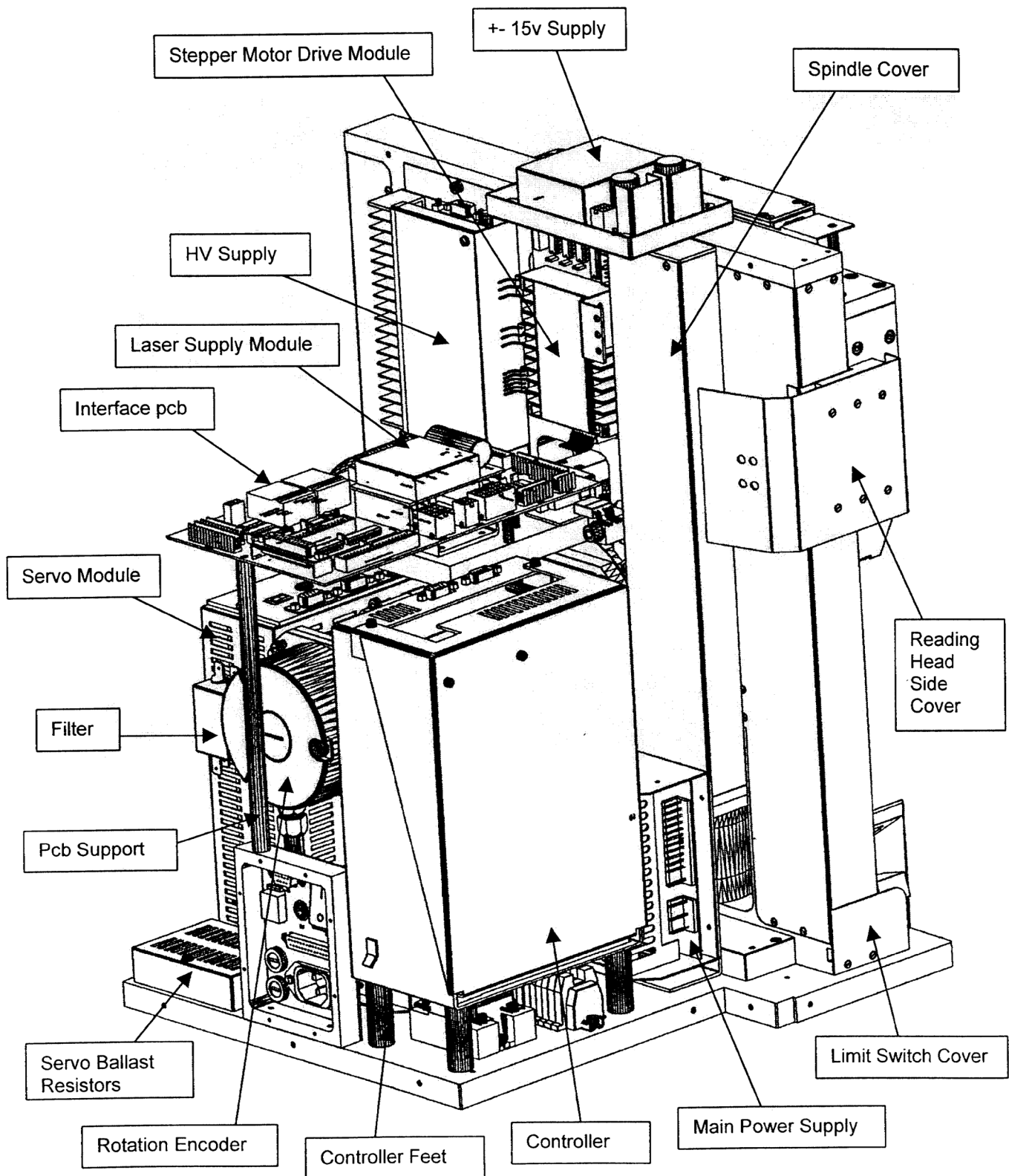

A.5 Replace erase lamps

As described in section 5.1, the **mar345S** detector system features 3 erase lamps in the front part of the detector. A replacement of the erase lamps is necessary if the software reports that the erase lamp has been off during the erase cycle. This message may also appear under certain circumstances even if the erase lamps are okay. The scanner has erase lamp sensors sitting close to the actual lamp. If the scanner makes one scan after another, it is possible that the scanner gets overheated. The scanner controller then does not even turn on the erase lamp after the scan and the software will show an error, even if the actual reason for the problem is not a broken lamp but too much heat. In those cases, let the scanner cool down a bit before continuing with your work. It is also possible that not the erase lamp itself is broken but rather the erase lamp sensor. A broken erase lamp sensor will always issue an error message even if the erase lamp is okay. Therefore, it is always good to check if the erase lamp is actually broken before throwing it away.

The scanner software will tell you which of the lamps is broken: either the upper erase lamp in the reading head or the lower left or lower right erase lamp (when looking from the front towards the image plate). When replacing the left or right erase lamp you should always replace both. To replace the erase lamp, please do the following:

- Turn off the detector.
- Remove front cover as shown in figure in Appendix A.1. Watch out for the earth cable connecting the front cover to the main chassis in the upper part of the cover!
- With the front cover open, you may consider to turn on again the detector and restart the software and make a single scan. With the front cover open, you should see at the end of the scan that one or more erase lamps are being turned on for about 15 seconds. If the erase lamp that is reported to be broken is not lit, proceed to replace it.
- If the scanner is still turned on, turn it off now.
- Open the protective cover of the corresponding erase lamps by removing the small hex screws. Make sure that you don't lose them!
- When replacing the upper erase lamp, remove the 2 reflector hex screws as shown below. When replacing the left or right erase lamp, the reflector is held by 2 screws of the cover. After removing the reflector you can remove the lamp from its socket. When inserting the new one, be careful not to touch the glass of the erase lamp with your fingers. This may considerably decrease lifetime of the bulb.
- Do not forget to put the reflector back in place before closing the covers. For the left or right erase lamp, the reflector has to be mounted together with the cover itself since 2 of the little screws will hold that reflector.
- Before closing the front cover, you may consider to do a scan with the front cover open as described above, so you can convince yourself, that the new lamp works as expected.

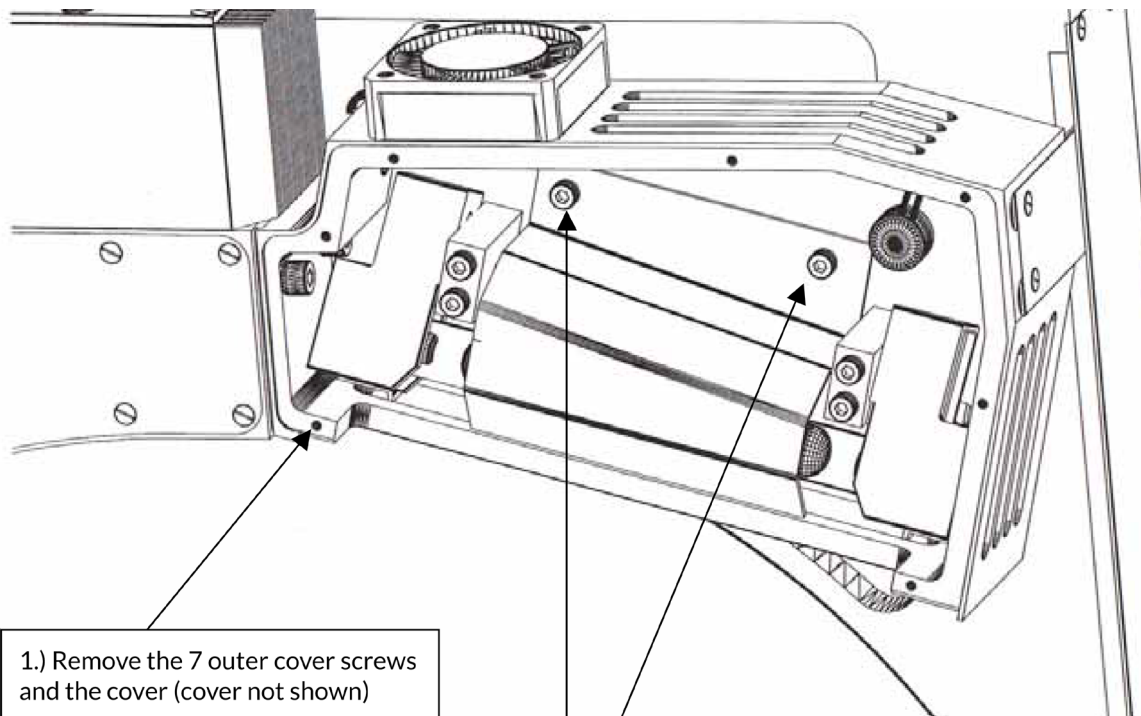

1.) Remove the 7 outer cover screws and the cover (cover not shown)

2.) Remove the 2 reflector hex screws and the reflector

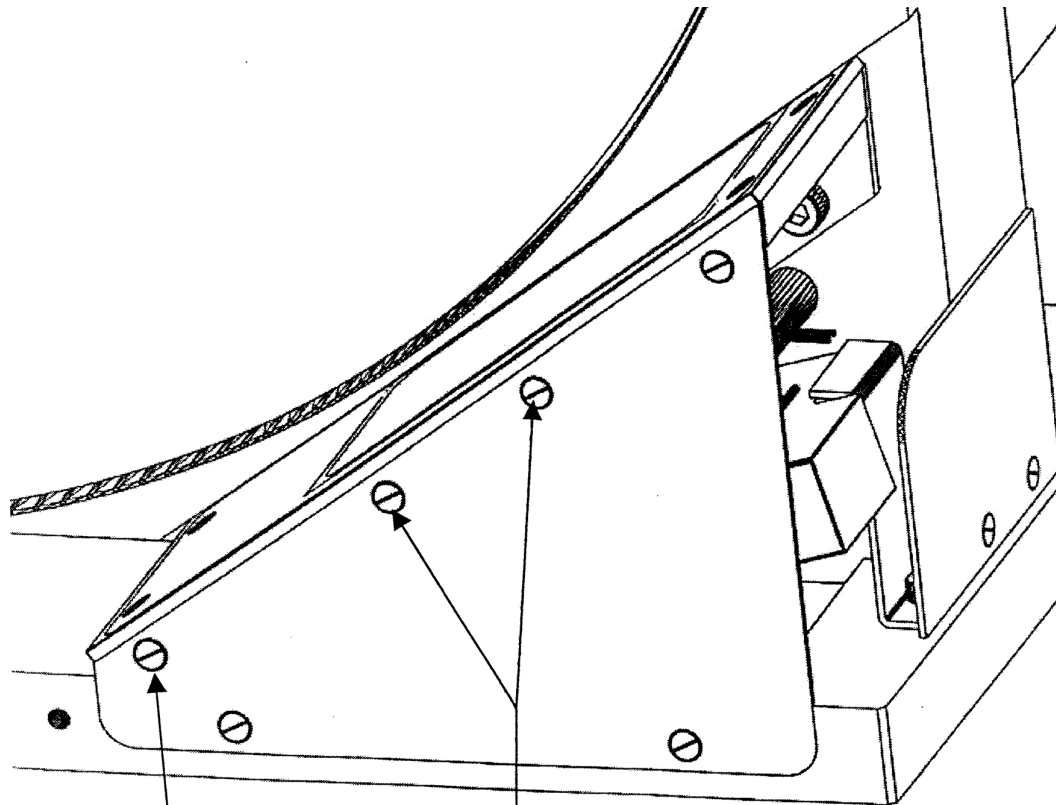

1.) Remove 6 erase lamp cover screws and remove cover.

Note: An angular metal reflector is mounted on the other side of the cover and will be released when the cover screws are removed. When refitting the cover, ensure that the reflector is mounted on the two screws shown.

2.) Remove the Lamp, (visible when cover removed), push to the left or right to release from the holder.

Note: Do not touch the replacement lamp with fingers, use the cloth supplied with the lamp

A.6 Replace filter mats

As described in section 5.2, the **mar345S** detector sytem comes with 7 filter mats that need to be cleaned or replaced in regular intervals, e.g. every 6 months. One set of replacement filter mats is shipped with the scanner. Additional sets must be obtained separately by ordering from marXperts. To access all filter mats, you have to remove ALL covers including the central one. Please remove front, rear and center cover of the detector as shown in sections A.1 and A.2, then do the following

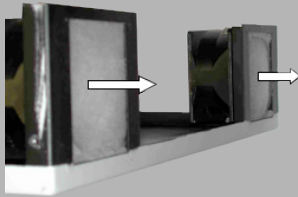
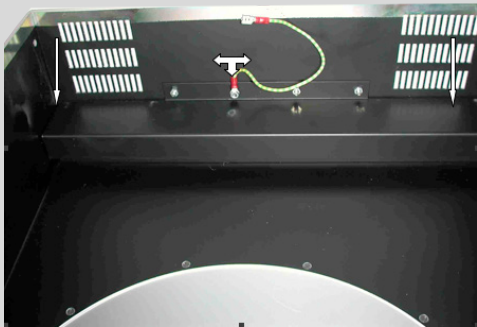
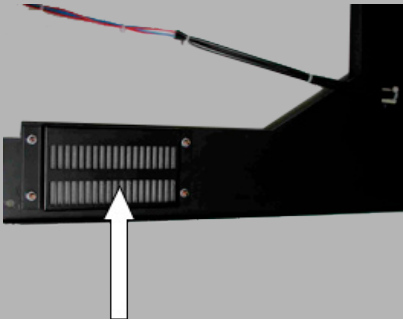
Description	
	In the rear cover, 2 filter mats sit behind the fans. To replace them, you have to remove the fans using appropriate 7 mm open wrench.
	In the center cover 2 filters mats sit on top of the fans and can be easily replaced without additional tools
	In the front cover 1 more filter mat sits above the mylar window and needs to be taken out by removing some screws. Watch out for the yellow/green earth cable
	In the center cover, 1 filter mats sits behind a cover that needs to taken off for replacement

A.7 Replace controller

To replace the controller of a **mar345S** detector, open up the rear cover and take out the scanner controller as shown in the following pictures by undoing 5 screws, 3 at the back and one at each side of the cover as shown in pictures 1 to 5. Please make sure to wear an antistatic wrist strap to prevent electrostatic discharge and irreversible damage to electrical components of the detector.

			
<p>(1)</p>	<p>(2)</p>	<p>(3)</p>	<p>(4)</p>
			
<p>5</p>	<p>6 Push cover slightly towards you</p>	<p>7 Lift cover slightly up</p>	<p>8 Tilt the cover towards you. Watch out: unplug cables before taking off (see fig. 9 & 10).</p>
			
<p>9 Carefully unplug the 15-pin marked XA41 on main PCB.</p>	<p>10 Before entirely taking off the cover, unplug the ground cable close to the black connector panel.</p>	<p>11 All done</p>	

When putting back the rear cover, just take the same steps in reverse order. Be especially careful to seat the XA41 connector in the right place. Make sure that it is not shifted by 1 pin.

	<p>WATCH OUT: if the XA41 (picture 9) connector is misplaced by 1 pin, the little board with the LEDs in the rear cover will be burnt and destroyed when powering up the scanner!</p>
--	--

Now, go on and remove the scanner controller by unplugging the cables as shown in pictures 12 to 19 and by undoing the 2.5 mm Allen keys that hold the legs of the controller as show in pictues 20 to 22.

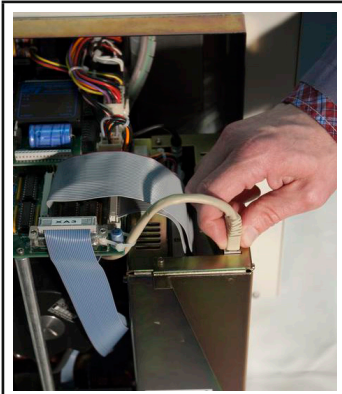

12) Network cable

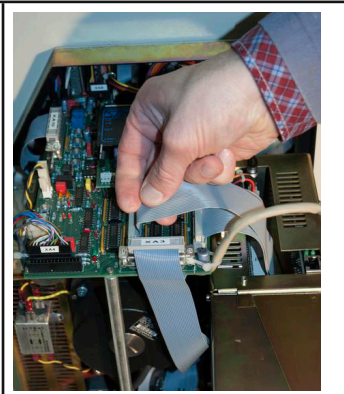

13) Long flat ribbon cable

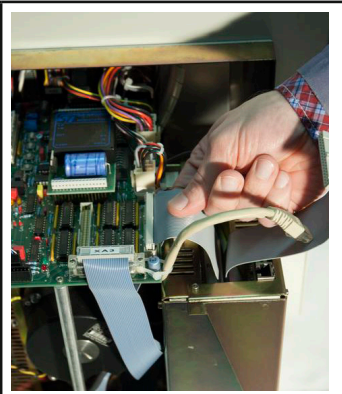

14) Short flat ribbon cable

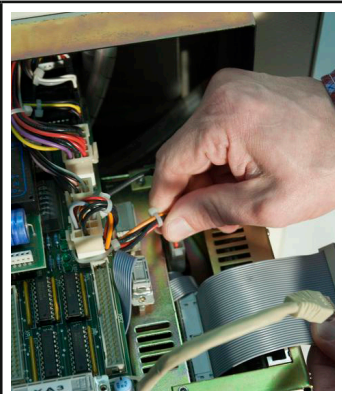

15) Power connector XA13 with 4 pins

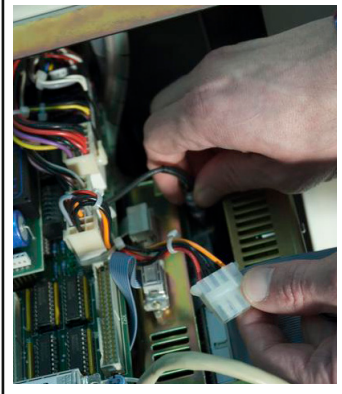

16) Black signal cable

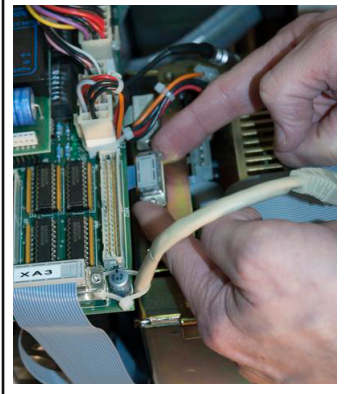

17) Dark grey male DB9 connector

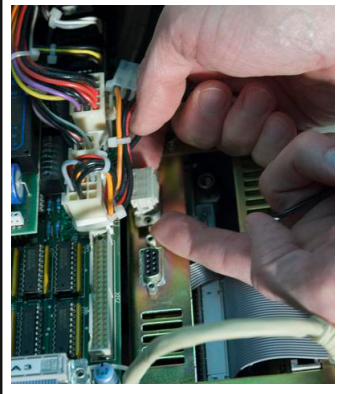

18) Light gray female DB9 connector

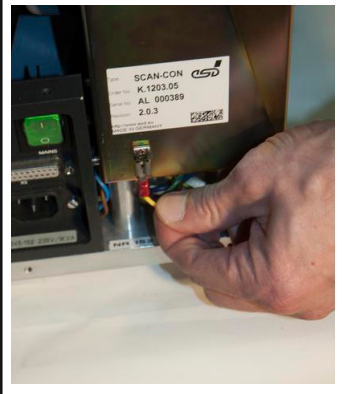

19) Yellow/green ground cable

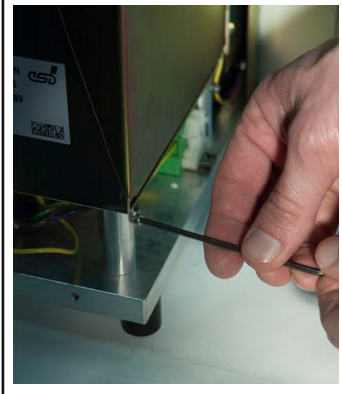

20) 2.5 mm Allen key for leg

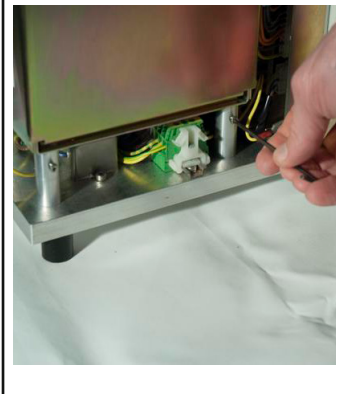

21) 2.5 mm Allen key for leg

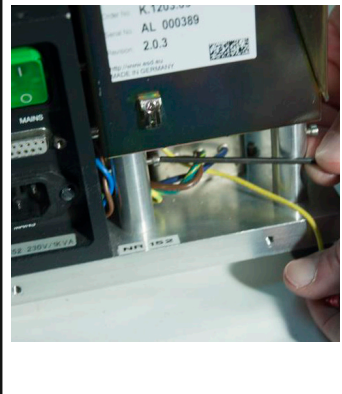

22) 2.5 mm Allen key for leg

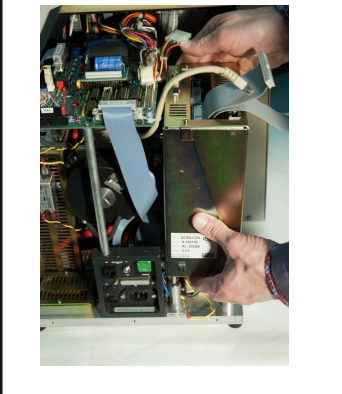

23) Lift the controller up and take it out

B. Mainboard

To access the mainboard of the mar345 scanner, the rear cover has to be removed (see section A.1). The main board contains power supplies, circuits and 4 push buttons to operate lower and upper erase lamps and move the reading head up and down.

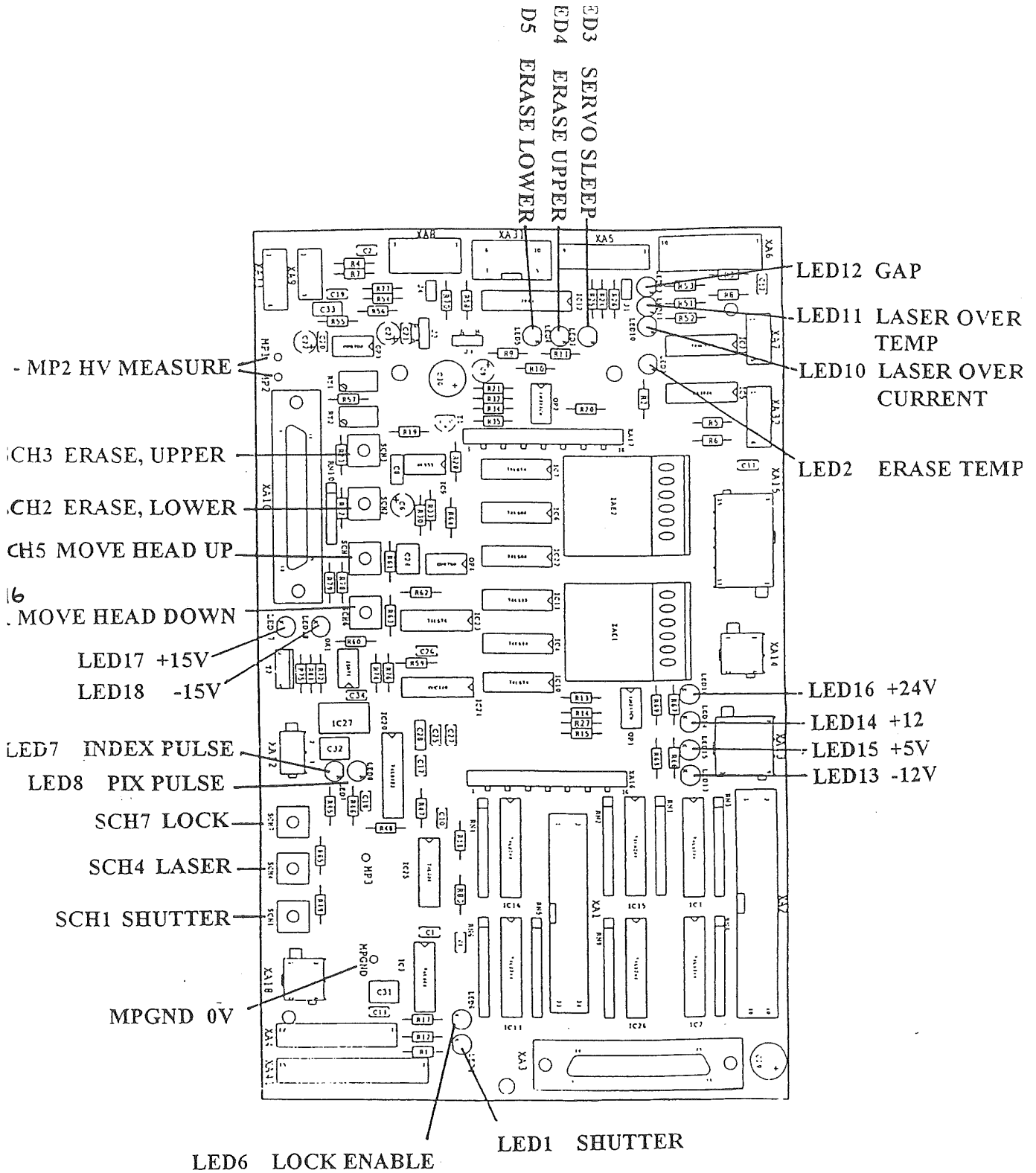

C. Back panel

The panel at the back of the **mar345S** detector contains the following connectors:

	(1) Power on/off
	(3) X3 = 25 pin connector with input and outputs for shutter, stepper drivers, etc. (see below)
	(1) Mains (240 V or 115 V)
	4) Serial number of detector
	5) F1/2: 5 A fuses for 240V, 10A fuses for 115 V versions
	6) RJ-45 Ethernet, 10MBit
	7) X0: Serial connector for "SPY" console
	8) HV: high voltage for ionization chambers of standard marresearch goniostat (unused in all other configurations)

The X3-connector is used on standard marresearch goniostat system for driving the distance translation motors, a PHI and omega stepper motor and to operate the X-ray shutter. The pin assignments for the 25-pin connector are as follows:

	1: GND	14: +5V DC
	2: GND	15: +15V DC
	3: AGND	16: -15V DC
	4: STEPGND	17: StepPWR1 (+12V DC)
	5: STEPGND	18: StepPWR2 (+12 V DC)
	6: +12V DC	19: Frequency/Intensity
	7: GND	20: Phi/Omega Clock
	8: Phi/Omega Direction	21: Omega Energize
	9: Phi Energize	22: Distance Clock
	10: Distance Direction	23: Distance Energize
	11: Distance Reference	24: Chamber Select Enable
	12: Beamshutter status	25: Open/Close Beamshutter
	13: GND	

The beamshutter open/close pin (25) can be used as a general purpose TTL signal. 0V on pin 25 against pin 2 (GND) opens the shutter, +5V closes it. The mar345 controller expects a feedback about the current status of the shutter on pin 12. When opening the beam shutter (0V on pin 25), the connected hardware has to feed back 0V into pin 12. When closing the beam shutter, +5V has to go to pin 12. If there is no feedback on pin 12, the hardware command to open or close a shutter will terminate with an error condition. If feedback from custom hardware is not available a bridge between pins 12 and 15 will always avoid to run in an error condition.

D. Spy console

The **mar345S** detector is normally operated via a network connection. The detector offers common TCP/IP-services like telnet and ftp as well as specialized TCP/IP-sockets to communicate with programs like mar345. Since the detector has got its own operating system (RT-OS), it is possible, though, to operate the instrument on a more basic level and to fully control all features of the operating system and the hardware. While detailed knowledge is required to do so, direct communication with the detector sometimes may be required for firmware upgrade procedures or for debugging purposes. The way to proceed is to use the D-Sub9 connector marked "SPY" (i.e. the uppermost of the D-Sub9 connectors) on the connector panel of the mardtb. You may either connect a VT100 terminal directly to that port or use a cross-over serial cable to connect to the COM-port of a laptop or a PC. Here we describe the procedure on how to connect a serial cable to a Linux PC and what to do to use it:

- Obtain a cross-over serial cable with D-Sub9 connectors.
- The pins in the serial cable must be as shown in the picture
- Connect the male part to the SPY port of the mar345 detector
- Connect the female part to the COM1 port of the PC or laptop
- Start a terminal emulator program

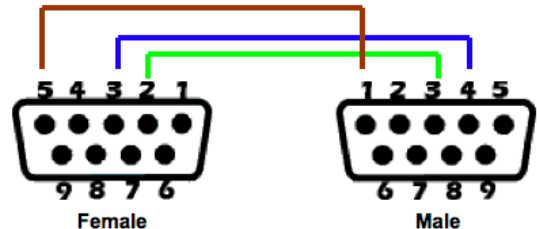

D.1 Linux

On Linux, you will have to use "kermit". If kermit is not installed, you will have to download it from the Internet. Look for a package suitable for your Linux distribution. The name of the package will be "ckermite" and some version number. For ease of use it is recommended to create a configuration file `$HOME/.kermrc` with the following contents:

```
set line /dev/ttyS0
set modem type NONE
set serial
set flow-control /DIRECT NONE
set flow xon/xoff
set speed 19200
set prompt \$(HOST) %
set term byte 8
set comm byte 8
SET CARRIER-WATCH OFF
LOG SESSION
```

This assumes that the serial cable is connected to COM1 (`/dev/ttyS0`). Check, that `/dev/ttyS0` has read/write permissions, otherwise the super-user must do:

```
chmod a+rw /dev/ttyS0
```

Invoke kermit using command:

```
kermit
```

If the serial cable is connected correctly, when turning on the detector you should get plenty of output on the kermit session. If not, check that

- the cable is properly connected to both the detector and the PC
- the type of cable (wiring) is correct
- `/dev/ttyS0` has read/write permissions
- the cable is not connected to COM2. If so, you will have to use `/dev/ttyS1`, instead

Thanks to line „LOG SESSION“ in the configuration file, all kermit output will be written into file `$HOME/session.log`. This is a convenient way to produce a mailable file that might be used for debugging purposes.

D.2 Windows

On Windows, you might want to use Hyperterm unless you have installed putty or some other terminal emulator program. Whatever program you are using, you need to specify two relevant settings, otherwise the same rules apply as above:

- the transmission speed (baud rate) must be set to 19200
- the terminal type must be set to VT100

Contents

1.	How to use this manual	1
1.1	Address and support	1
1.2	Security and handling	2
1.3	Disclaimer	2
2.	Overview	3
2.1	Detector configurations	3
2.2	Data collection configurations	4
3.	Software	5
3.1	Software distribution	5
3.2	Detector driving programs	5
4.	First steps	6
4.1	Starting up	6
4.2	Scanning	6
5.	Maintenance	7
5.1	Erase lamps	7
5.2	Filter mats	7
5.3	Image plate	7
6.	Troubleshooting	8
7.	Specifications	8
--	Appendix	9
A	Service and maintenance	9
A.1	Remove front and rear cover	9
A.2	Remove center cover	10
A.3	Scanner front	11
A.4	Scanner back	12
A.5	Replace erase lamps	14
A.5	Replace filter mats	15
A.5	Replace controller	16
B	Mainboard	18
C	Back panel	19
D	Spy console	20
D.1	Linux	20
D.2	Windows	20

EC Conformity Declaration

marresearch

X-Ray Research GmbH - Segeberger Chaussee 34 - D-22850 Norderstedt

The device named below fulfills the relevant fundamental requirements of the EC directives and standards listed. Unauthorized modifications to the device invalidates this declaration.

mar345 Imaging Plate System

Relevant EC directives/standards:

89/336/EWG, EN50082-1, EN55011, EN61000-3-2/3

73/23/EWG, EN61010-1

Norderstedt, Date:

11. Nov. 97

Project Management:

Andreas Genthner

